

# INSTALLATION | DECK FOOT ANCHOR™

## IMPORTANT NOTE :

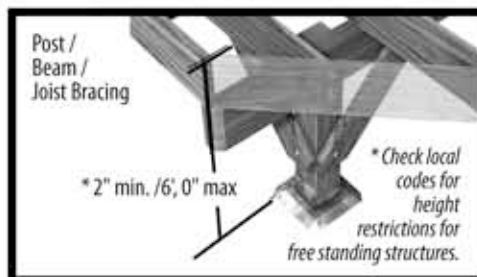

CHECK YOUR LOCAL BUILDING DEPARTMENT FOR HEIGHT REQUIREMENTS REGARDING FREE STANDING STRUCTURES.

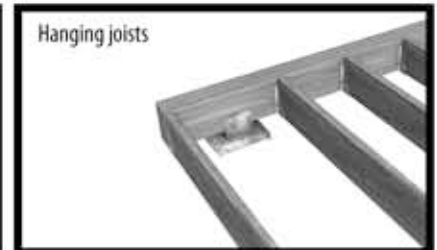
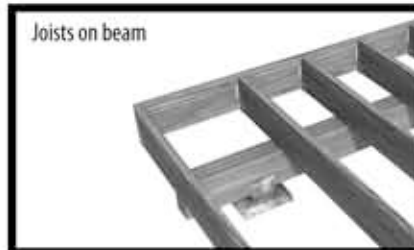
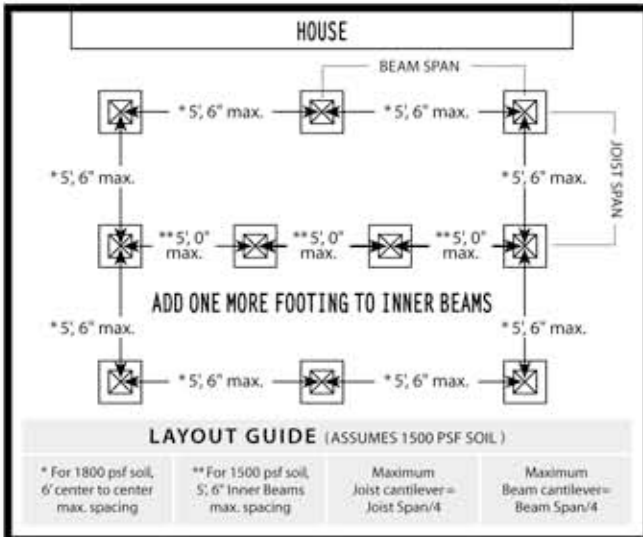
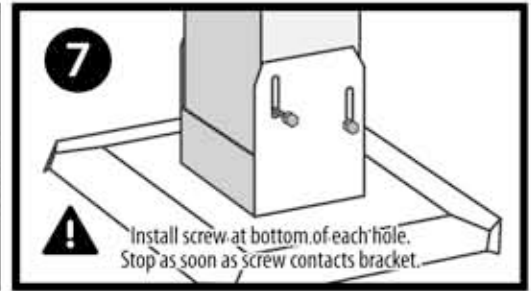
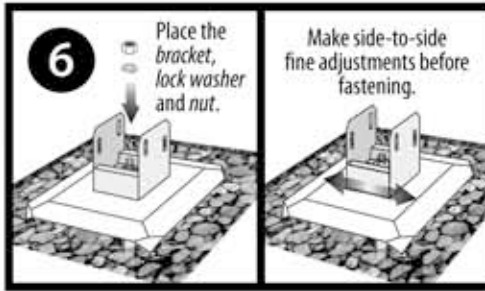
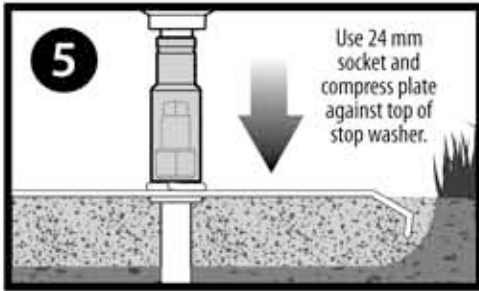
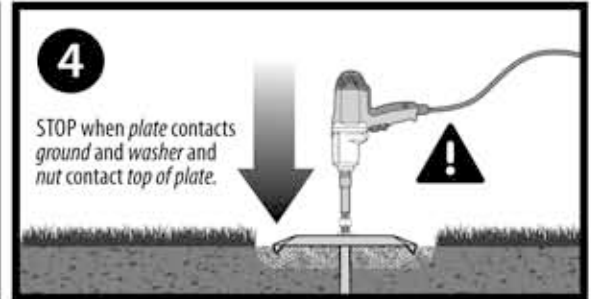
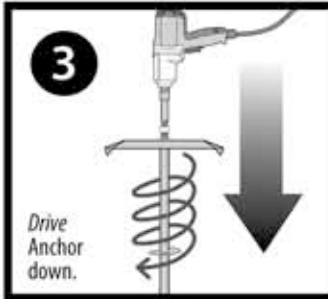
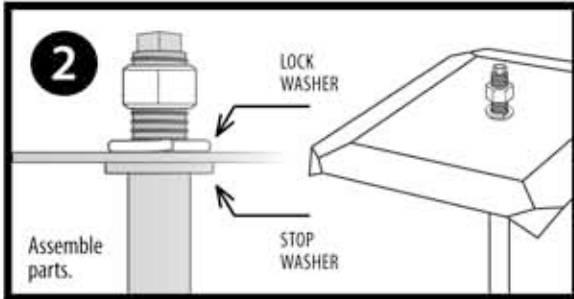
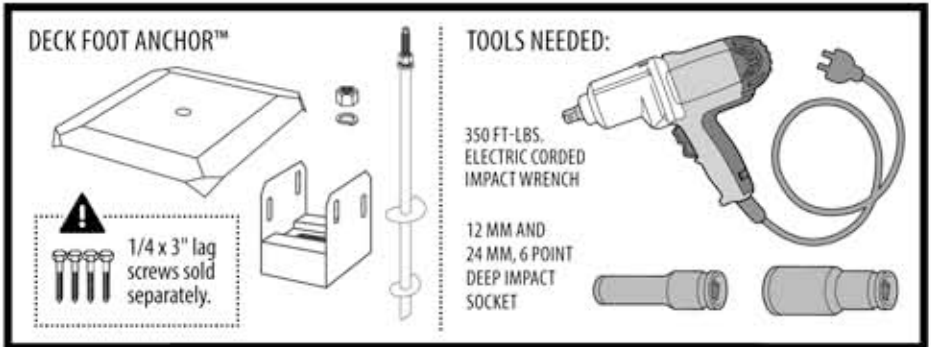
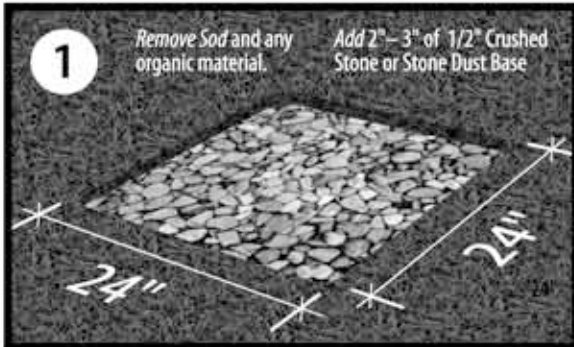

TITAN DECK FOOT ANCHOR™ / TIDP442 / TIDP662 / TIDKP / TIGA600 / TIGA900

PATENT NO US 9,309,688

ATTENTION: Before beginning work, consult with local building officials or engage professionals to ensure that this product is appropriate for your intended use or help clarify if these warnings are unclear or if you do not understand any of the information in this installation guide. Always comply with applicable building codes and be advised that building codes may vary.

ADVERTENCIA : Antes de comenzar a trabajar, consulte con funcionarios de la construcción local o contrate profesionales para asegurarse de que este producto sea apropiado para la aplicación deseada o para para ayudar a clarificar en caso de que estas advertencias no sean claras o en caso de que usted no comprenda parte de la información de esta guía de instalación. Siempre cumpla con los códigos de construcción aplicables y sepa que los códigos de la construcción pueden variar.

ATTENTION : Avant de commencer le travail, consultez les autorités locales en construction ou embauchez des professionnels pour assure que ce produit est approprié pour l'application que vous avez en vue ou pour aider à clarifier ces instructions si elles ne sont pas claires ou si vous ne comprenez pas quelque information que ce soit dans ce guide d'installation. Conformez vous toujours aux codes du bâtiment qui s'appliquent à sachez que les codes du bâtiment peuvent varier d'un endroit à un autre.

IN NO EVENT SHALL TITAN BUILDING PRODUCTS BE LIABLE FOR ANY LOSS OR DAMAGE, DIRECT OR OTHERWISE, WHICH RESULTS FROM THE IMPROPER INSTALLATION OR USE OF THIS PRODUCT. IF FOR ANY REASON TITAN BUILDING PRODUCTS BECOMES LIABLE FOR LOSS OR DAMAGE, DIRECT OR OTHERWISE, THE AGGREGATE LIABILITY OF TITAN BUILDING PRODUCTS SHALL BE LIMITED TO THE RETAIL PURCHASE PRICE OF THE PRODUCTS.

QUESTIONS? CONTACT US TOLL FREE  
**1-866-577-8868**



titanbuildingproducts.com

# INSTALLATION | DECK FOOT ANCHOR™

SLOPED GRADES

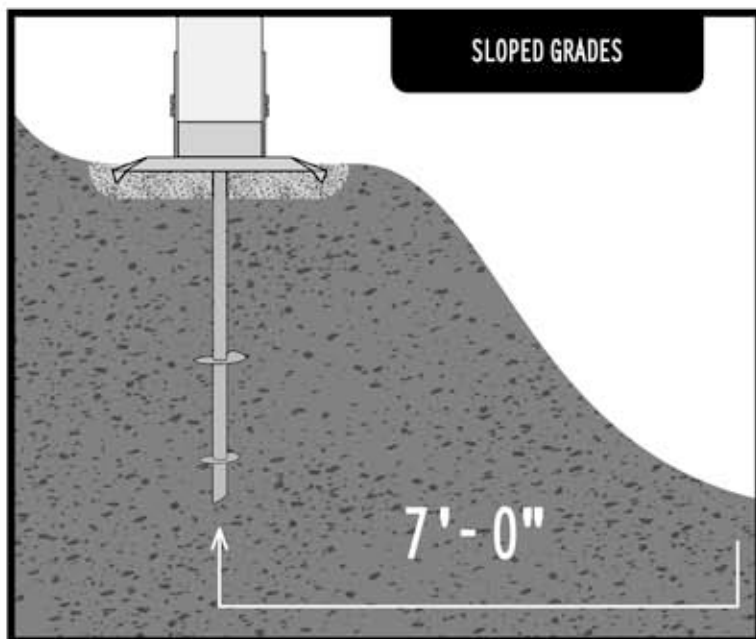

DO NOT ATTACH TO HOUSE

\*Designed for non-ledger attached decks.

\*EXCEPTION ALLOWED WHERE GROUND DOES NOT FREEZE.  
NOT RECOMMENDED FOR SECOND STOREY WALKOUT DECKS.  
NOT INTENDED FOR FENCES OR OTHER STRUCTURES  
REQUIRING LATERAL LOAD RESISTANCE.

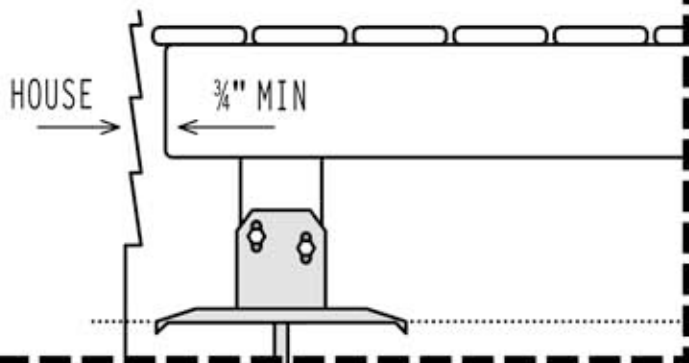

## Introducing Terra-Shift™

“A SHOCK ABSORBER SYSTEM FOR YOUR DECK”

The Titan Deck Foot Anchor™ uses our patented Terra-Shift™ post bracket system to help keep soil around the anchor undisturbed and prevent damage to all post and beam and other structural connections.

**TERRA-SHIFT™**  
Technology

Here is how it works:

The fastener slide holes reduce friction between the

post and bracket just enough so that if the soil shifts or expands unevenly along a series of footings under a beam, the post is free to slide vertically and then settle back to normal. It's like a shock absorbing system for your deck.

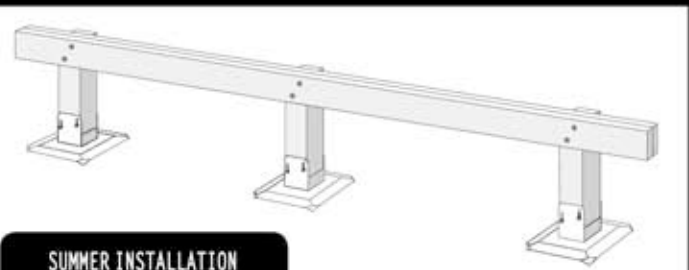
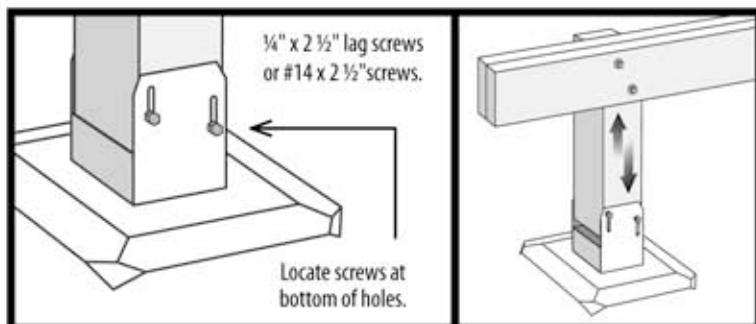

SUMMER INSTALLATION

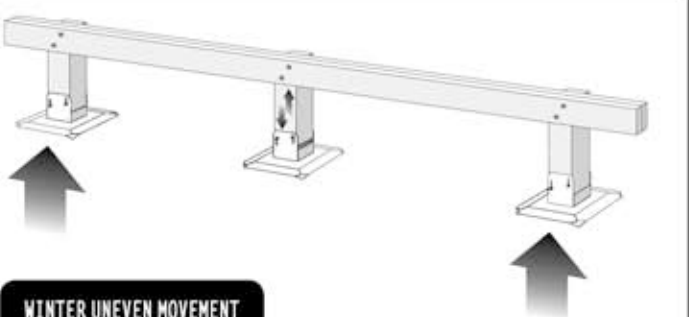

WINTER UNEVEN MOVEMENT



SPRING SETTLING

TITAN DECK FOOT ANCHOR™ / TIDP442 / TIDP662 / TIDKP / TIGA600 / TIGA900

PATENT NO US 9,309,688

ATTENTION: Before beginning work, consult with local building officials or engage professionals to ensure that this product is appropriate for your intended use or help clarify if these warnings are unclear or if you do not understand any of the information in this installation guide. Always comply with applicable building codes and be advised that building codes may vary.

ADVERTENCIA : Antes de comenzar a trabajar, consulte con funcionarios de la construcción local o contrate profesionales para asegurarse de que este producto sea apropiado para la aplicación deseada o para para ayudar a clarificar en caso de que estas advertencias no sean claras o en caso de que usted no comprenda parte de la información de esta guía de instalación. Siempre cumpla con los códigos de construcción aplicables y sepa que los códigos de la construcción pueden variar.

ATTENTION : Avant de commencer le travail, consultez les autorités locales en construction ou embauchez des professionnels pour assure que ce produit est approprié pour l'application que vous avez en vue ou pour aider à clarifier ces instructions si elles ne sont pas claires ou si vous ne comprenez pas quelque information que ce soit dans ce guide d'installation. Conformez vous toujours aux codes du bâtiment qui s'appliquent à sachez que les codes du bâtiment peuvent varier d'un endroit à un autre.

**QUESTIONS? CONTACT US AT 1-866-577-8868** IN NO EVENT SHALL TITAN BUILDING PRODUCTS BE LIABLE FOR ANY LOSS OR DAMAGE, DIRECT OR OTHERWISE, WHICH RESULTS FROM THE IMPROPER INSTALLATION OR USE OF THIS PRODUCT. IF FOR ANY REASON TITAN BUILDING PRODUCTS BECOMES LIABLE FOR LOSS OR DAMAGE, DIRECT OR OTHERWISE, THE AGGREGATE LIABILITY OF TITAN BUILDING PRODUCTS SHALL BE LIMITED TO THE RETAIL PURCHASE PRICE OF THE PRODUCTS.

QUESTIONS? CONTACT US TOLL FREE

**1-866-577-8868**

**TITAN™**  
BUILDING PRODUCTS  
THE ART OF BUILDING



titanbuildingproducts.com

